

Benchtop X-Ray CT System

# XSeeker 8000



# Designed for Simplicity

# XSeeker™ 8000



The XSeeker 8000 bench-top X-ray computed tomography (CT) system is equipped with a high-output X-ray generator and a high-resolution flat panel detector. Despite its compact size, it has a high X-ray output of 160 kV, enabling clear observations of molded plastic parts as well as aluminum die cast parts and other metal parts.

In addition, the newly developed XSeeker control software provides high operability and the highest throughput to date.

With clear image quality and high throughput, it supports applications in a wide range of situations, from detailed observations in product development and quality evaluation to inspections at machining sites.

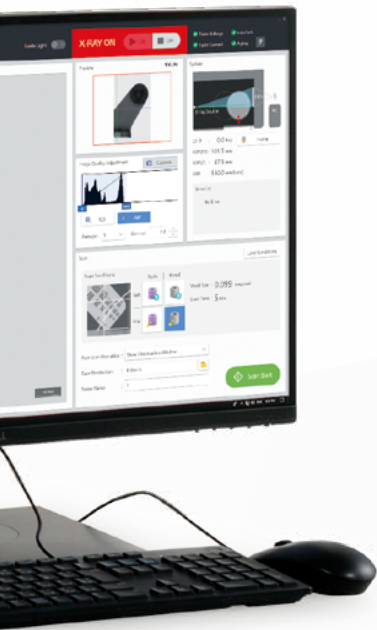

## Compact, High-Output System

### Smallest, Lightest Bench-Top CT System in Its X-Ray Output Class

This system is equipped with a 160 kV high-output X-ray generator, enabling observations of thick, hard-to-penetrate plastic parts, as well as aluminum die cast parts and other metal parts. It is the smallest and lightest system in its X-ray output class, so it can be installed anywhere.

---

P.4

## Image Quality and Functionality on Par with High-End Models

### High-Accuracy Scanning Utilizing a Maximum Input Resolution of 5.6 Million Pixels

High-accuracy scanning is achieved in offset scan mode, which provides both a wide 100 mm diameter scanning field of view and an input resolution equivalent to up to 5.6 million pixels. In addition, the CT data viewer is equipped as standard with a VR (3D) display function, enabling more intuitive observations coordinated with the cross-sectional display function.

---

P.5

## Operation Optimized for Inspections

### New Functionality Provides Easy Operation and High Throughput

Just a 3-step process enables starting observations. Even users with no operating experience can start CT scanning immediately. In addition, in repetitive scanning in inspection applications, all the processes from starting scanning to observing the cross sections of interest are available at the push of a button.

---

P.6-9

# Compact, High-Output System

## Smallest, Lightest Bench-Top CT System in Its Class

It is the smallest and lightest bench-top system in its X-ray output class, so it can be installed anywhere. Since the system size and weight meet the minimum standards for loading into a general passenger elevator in Japan (as per P-6-C \*JIS A 4301-1983), there are no difficulties related to delivering the system.



## High 160 kV Output Achieves High Penetration Ability

Thanks to its 160 kV X-ray output, the system can observe thick, hard-to-penetrate plastic and metal parts. Note: The following are reference values.

### X-Ray Transmittance Comparison between 100 kV and 160 kV

Material	Ratio of X-Ray Transmittance 100 kV:160 kV
Plastic	1:1.2
Aluminum	1:1.4
Iron	1:2.0

### Image when Penetrating 100 mm of Aluminum

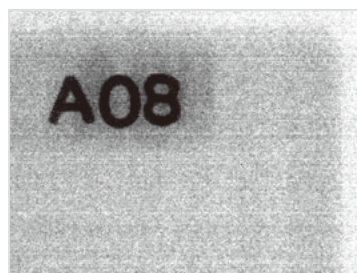

100 kV Output System

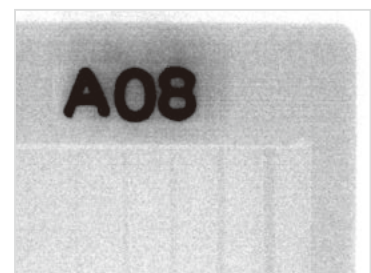

XSeeker 8000 (160 kV output)

# Image Quality and Functionality on Par with High-End Models

## High-Accuracy Scanning Utilizing a Maximum Input Resolution of 5.6 Million Pixels

The offset scan layout extends the width to approximately twice that of conventional normal scans, resulting in an input resolution equivalent to 5.6 million pixels. The system provides high-accuracy scanning across a wide 100 mm diameter field of view size.

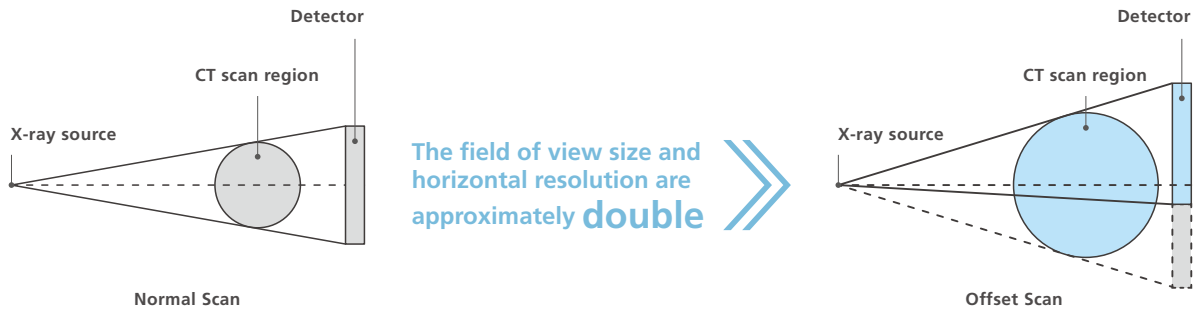

## Equipped with a 50 $\mu\text{m}$ Pixel Pitch Flat Panel Detector

The system is equipped with a flat panel detector with fine picture elements measuring approximately 50  $\mu\text{m}$  per pixel. This is the smallest pixel pitch of any equivalent class instrument, enabling sharp observations down to the level of fine structures.

## Equipped as Standard with a High-Functionality All-In-One Viewer

The system is equipped with a high-functionality viewer with multiple functions. In addition to an MPR display, which shows multiple cross-sectional images side by side, this can be combined with a VR display capable of 3D displays, resulting in more intuitive observations. Measurement can be performed on both MPR images and VR images. Further, the CT data can be converted to mesh data (STL) for output. Data converted to STL can be utilized in a variety of applications, such as loading into 3D CAD or outputting with a 3D printer.



# Operation Optimized for Inspections

## 3-Step Scanning

A simple 3-step process enables starting observations. Upon installation, new operators can run the system with minimal training.

Calibration is not required prior to sample placement.

STEP  
01

### Positioning the Sample

The system is equipped with a unique sample placement support mechanism. It visualizes the CT-Scan region with guide lights to enable easier sample placement.

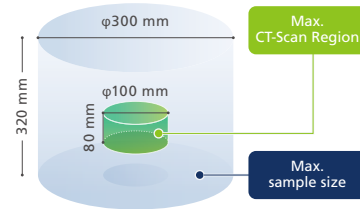

STEP  
02

### Setting the Scanning Conditions

The conditions can be selected with a single click from four simple conditions buttons. (Recommend Scanning Function: Page 8)

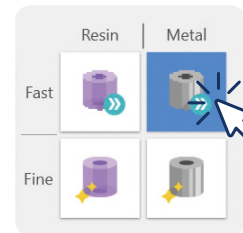

STEP  
03

### Scanning

Click the Scan start button to start scanning. Scanning takes as little as 12 seconds.

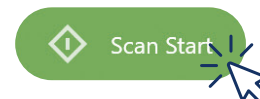

## Observation

In the observation window, the displayed position, brightness, and contrast of the cross-sectional and VR images are adjusted to ensure the optimal display of the region to observe.

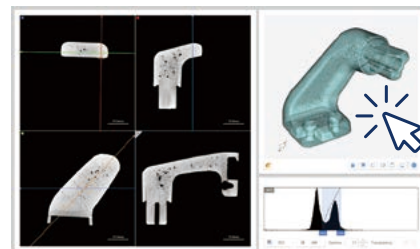

## Operation at the Push of a Button

In inspection applications with repeated scanning of samples with the same shape, operation at the push of a button enhances throughput.

The optimal conditions, including the position displayed and the contrast during observations, are recorded together with the scanning conditions. This allows observations to begin immediately after scanning without adjusting the observation position or contrast. All operations from starting the scanning to observing the results can be completed at the push of a button, without any software operations.



STEP  
01

Setting the scanning conditions is unnecessary!

### Positioning the Sample

Samples with the same shape are positioned at a set position on the stage. A function reproduces the scanning conditions, making it unnecessary to set the conditions again for each sample.

STEP  
02

Setting observation conditions automatically!

### Scanning and Observation

After positioning the sample, press the CT start button on the main unit to start scanning. The observation conditions are automatically set, so with just a push of a button, the region to observe is displayed with the optimal conditions.



# Operation Optimized for Inspections

## Scanning in as Little as 12 Seconds and High-Speed Reconstruction Calculations

High-speed scanning can take as little as 12 seconds. In addition, the system is equipped with the same reconstruction system as high-end models, so CT data can be displayed a mere 10 seconds after scanning is complete. This is approximately twice as fast as Shimadzu's other CT models.

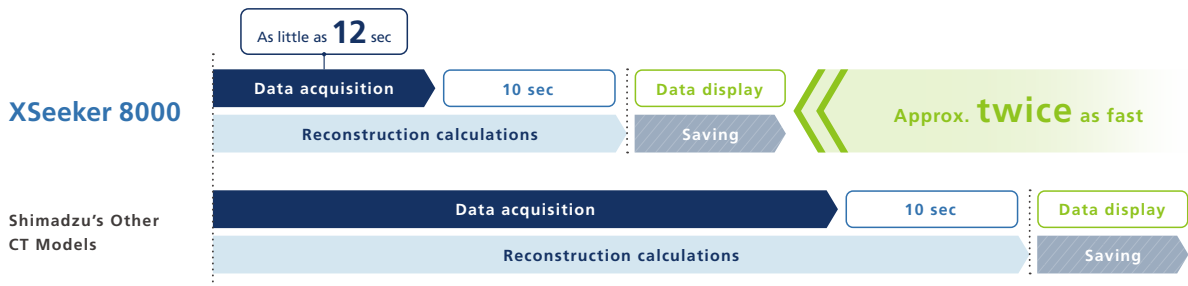

## Newly Developed Control Software Enables Intuitive Operations

The simple user interface which eliminates complicated steps, enables intuitive operation so that anyone can easily use the system.

There are dedicated windows for scanning and observation, respectively, and the user is free to switch between them.

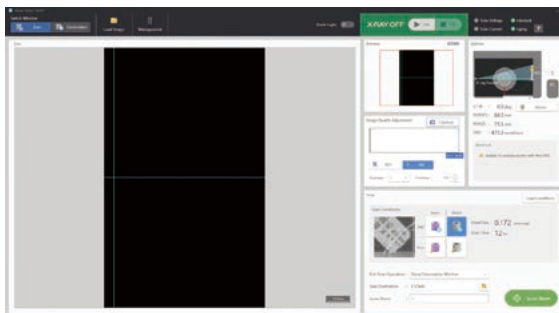

Scan Window

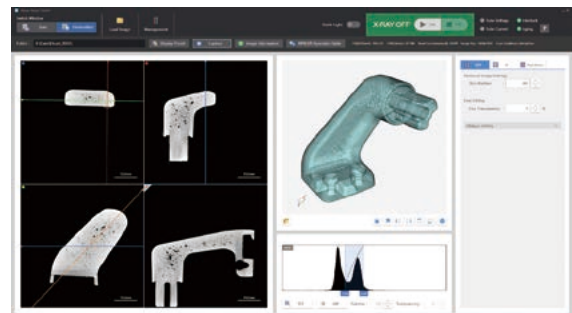

Observation Window

### Recommend Scanning Function



The system is equipped with an recommend scanning function, which can set all the scanning conditions with a single click. The optimal scanning conditions can be set easily just by selecting one combination of material and image quality.

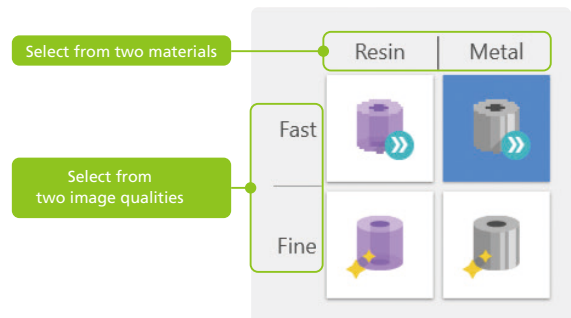



# Supporting the Safety and Security of Users

## Status Monitor

In addition to displaying the instrument status, including the stage position during normal operation, the monitor provides details of any errors that occur during abnormal operation and the site where the problem occurs, so the operator is notified of the problem immediately.

The status of the system as a whole is always monitored, from warnings that the sliding door is not shut, for example, to alarms indicating overheating of the X-ray generator and communications faults.

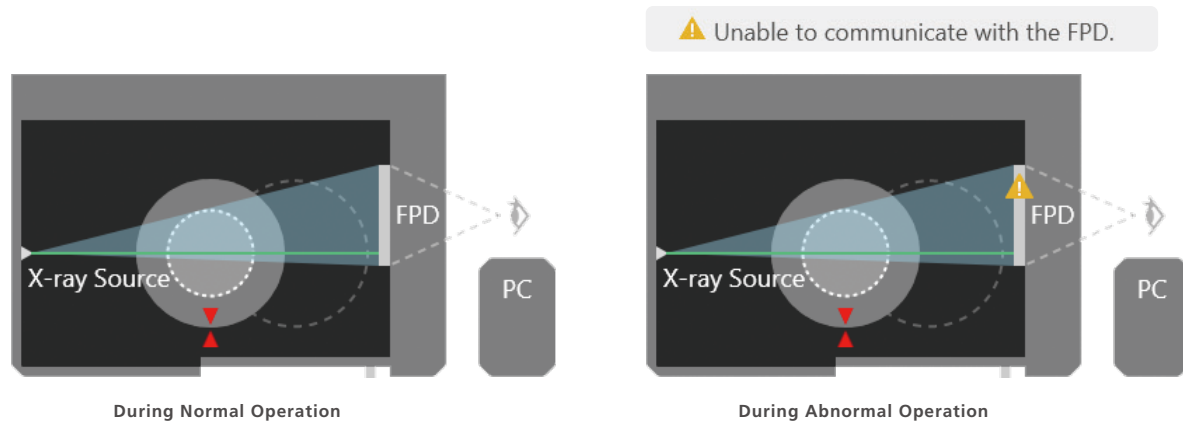

## Safety Compliant with CE Marking

### 1 $\mu$ Sv/h or less external X-ray leakage

Equipped with a safety box to ensure that the above-mentioned leakage is not exceeded even with 90 inspections per hour.

### CE-compliant design

The interlock, indicators, and other safety features are designed for compliance with CE marking.

### Door damper for preventing jammed fingers

The damping mechanism ensures that the sliding door moves slowly and quietly when samples are inserted or removed, so jammed fingers are prevented.

### Electromagnetic lock

The system is equipped with an electromagnetic lock mechanism, so the sliding door cannot be opened during irradiation.

### Safe rotating table control

The power is shut down while the sliding door is open so that the rotating table cannot move.



# Applications

## ● Aluminum Diecast: Piston for Motorcycle

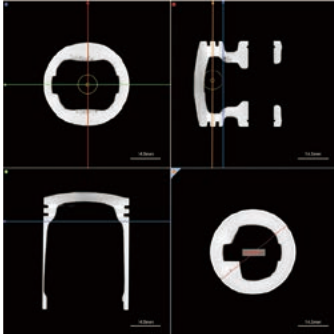

Cross-sectional image  
(Dimension measurement)

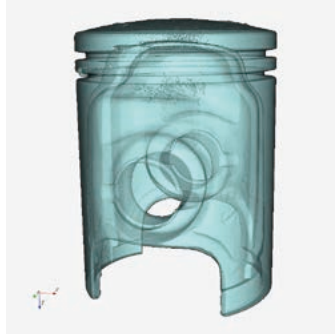

VR Image

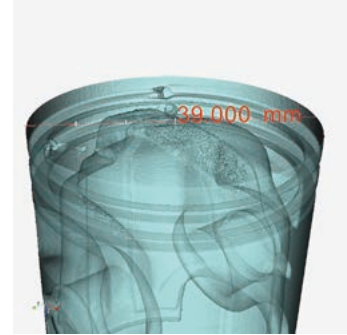

VR Image  
(Dimension measurement)

## ● Aluminum Diecast: Drone engine parts

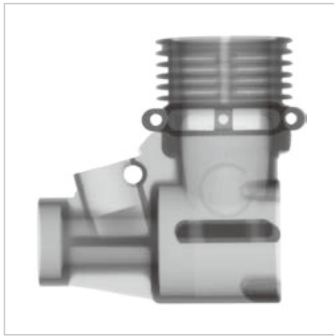

Fluoroscopic image

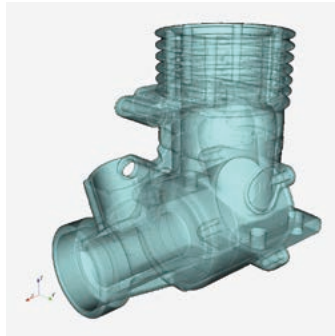

VR Image

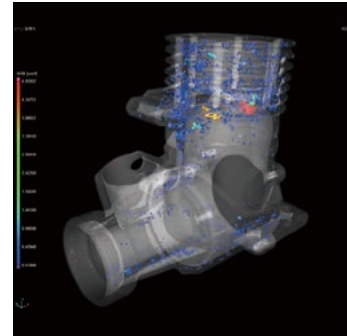

Defect Analysis  
(VGSTUDIO MAX)

## ● Resin parts: Motorcycle turn signal lamps

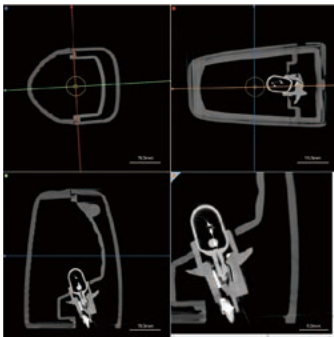

Cross-sectional image



VR Image

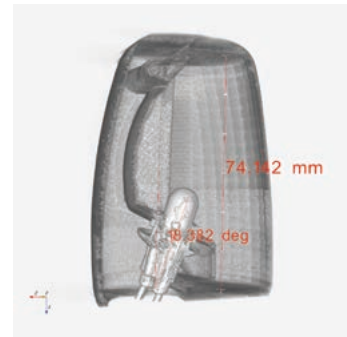

VR Image  
(Dimension measurement)

## ● Resin Parts: Cable gland

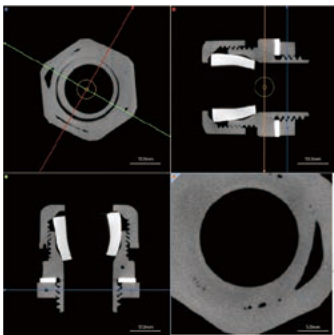

Fluoroscopic image

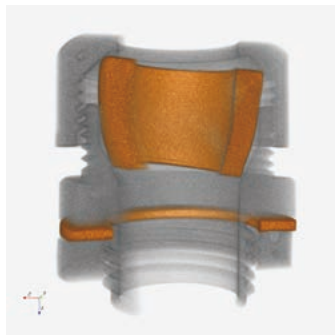

VR Image

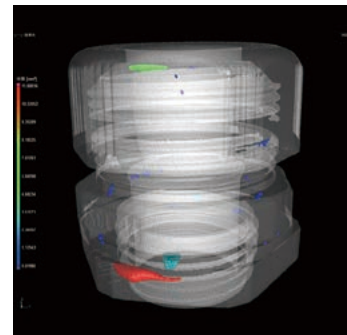

Defect Analysis  
(VGSTUDIO MAX)

● **Electrical parts: AC adapters**

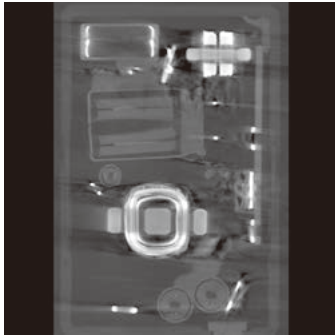

Cross-sectional image



VR Image

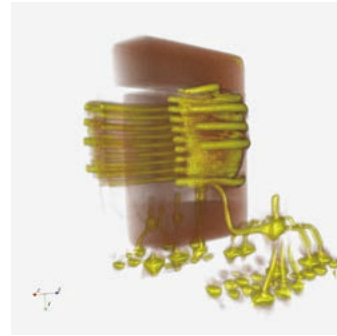

VR Image  
(Coil Part Enlarged)

● **Metallic AM: Acetabular samples**

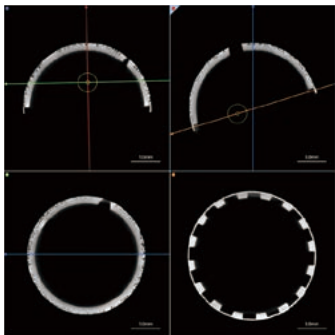

Cross-sectional image

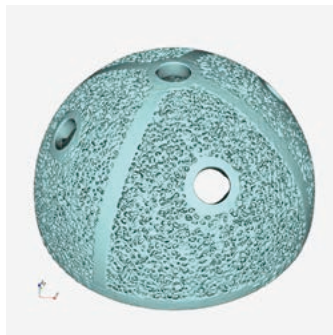

VR Image

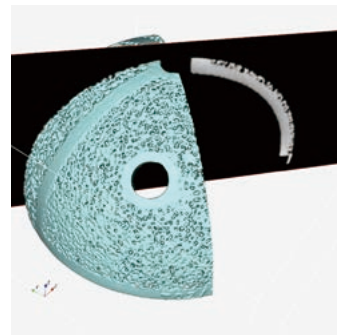

VR Image

● **Bone: tarsier**

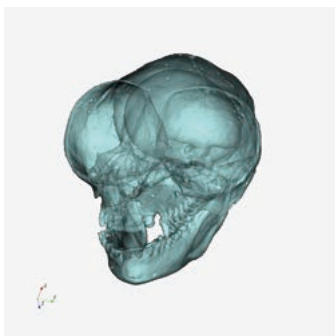

VR Image

● **Food: Cup noodles (mini size)**

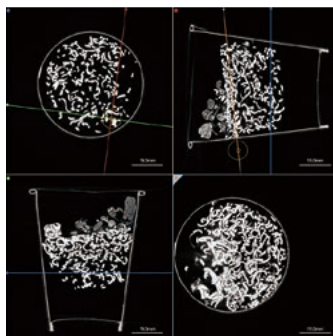

Cross-sectional image



VR Image

**Optional Software**

● **VGSTUDIO MAX**

This is high-functionality volume rendering (VR) software. It has functions for creating animations, various measurements, extraction of regions of interest, image filtering processes, and positional alignment of 3D images.

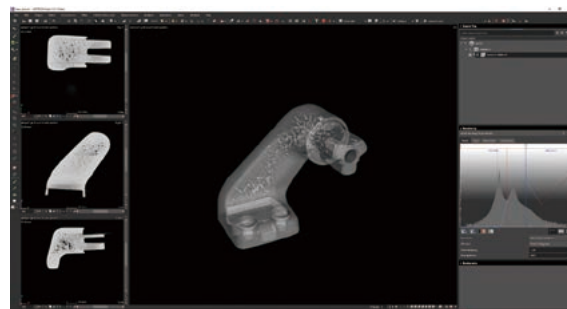

## Main Specifications

X-Ray Generator Output		160 kV 1.2 mA	
X-Ray Detector		Flat panel detector	
Max. Input Resolution		Approx. 5.6 million pixels	
Max. Sample Size/Weight		SRD*1 = 475 mm	φ 300 mm×H 320 mm, 10 kg (Including sample setting jig)
		SRD = 550 mm	φ 150 mm×H 320 mm, 10 kg (Including sample setting jig)
Max. CT-Scan Region		SRD = 475 mm	φ 85 mm×H 70 mm
		SRD = 550 mm	φ 100 mm×H 80 mm
Spatial Resolution		100 μm (SRD = 550 mm)	
CT Data Acquisition Time		12 sec or 5 min	
Rated Output	Main Unit	Single phase 100 to 240 V AC ± 10 %, 50/60 Hz, 1.0 kVA	
	Control Computer	Single phase 100 to 240 V AC ± 10 %, 50/60 Hz, 1.0 kVA	
	Grounding	D type grounding (Grounding resistance of 100 Ω max.)	
Weight		290 kg	
Operating Environment Conditions		Ambient temperature: 10 to 30 °C; Ambient humidity: RH of 45 to 80 % max. (No condensation)	
External Leakage Dose		1 μSv/h or less.	

\*1 SRD: The source-to-rotation center distance (SRD) is the distance from the X-ray source to the rotation center of the sample.

## XSeeker 8000 Image and Layout (Units: mm)

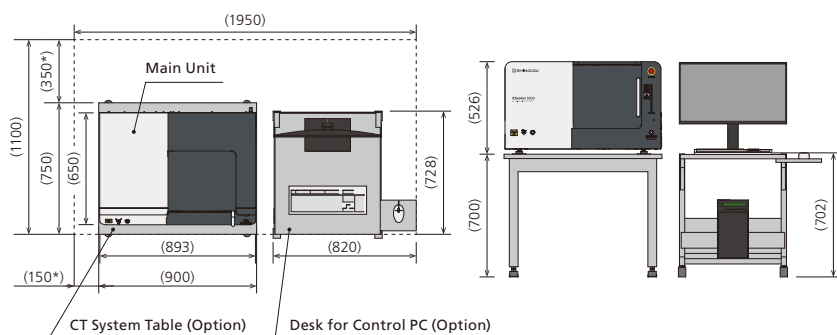

Recommended Installation Space: W1950 × D1100 mm

Note: Leave at least 350 mm of space behind the CT system table and 150mm of space left side in order to permit access for maintenance work.



### ANALYTICAL INTELLIGENCE

- Automated support functions utilizing digital technologies, such as M2M, IoT, and Artificial Intelligence (AI), that enable higher productivity and maximum reliability.
- Allows a system to monitor and diagnose itself, handle any issues during data acquisition without user input, and automatically behave as if it were operated by an expert.
- Supports the acquisition of high quality, reproducible data regardless of an operator's skill level for both routine and demanding applications.

XSeeker and the Analytical Intelligence logo are trademarks of Shimadzu Corporation or its affiliated companies in Japan and/or other countries. VGSTUDIO MAX is a trademark of Volume Graphics GmbH.



Shimadzu Corporation

[www.shimadzu.com/an/](http://www.shimadzu.com/an/)

#### For Research Use Only. Not for use in diagnostic procedures.

This publication may contain references to products that are not available in your country. Please contact us to check the availability of these products in your country.

Company names, products/service names and logos used in this publication are trademarks and trade names of Shimadzu Corporation, its subsidiaries or its affiliates, whether or not they are used with trademark symbol "TM" or "®".

Third-party trademarks and trade names may be used in this publication to refer to either the entities or their products/services, whether or not they are used with trademark symbol "TM" or "®".

Shimadzu disclaims any proprietary interest in trademarks and trade names other than its own.

The contents of this publication are provided to you "as is" without warranty of any kind, and are subject to change without notice. Shimadzu does not assume any responsibility or liability for any damage, whether direct or indirect, relating to the use of this publication.